



# OUTDOOR KITCHEN

CATALOGO GENERALE // GENERAL CATALOG





Scopri la linea **outdoor kitchen** su [lisaoutdoor.com](http://lisaoutdoor.com)  
Discover the **outdoor kitchen** line on [lisaoutdoor.com](http://lisaoutdoor.com)



**LEGENDA / LEGEND**



USO INTERNO / INDOOR USE



USO ESTERNO PROTETTO / PROTECTED OUTDOOR USE

|           |                                                                                               |
|-----------|-----------------------------------------------------------------------------------------------|
| <b>4</b>  | <b>Da 18 anni la qualità al primo posto</b> // <i>Since 18 years, quality in first place</i>  |
| <b>6</b>  | <b>L'outdoor kitchen, da sogno a realtà</b> // <i>Outdoor kitchen, from dream to reality</i>  |
| <b>8</b>  | <b>Cucine nate forti e gentili</b> // <i>Kitchen born "strong and gentle"</i>                 |
| <b>10</b> | <b>Perchè scegliere LISA</b> // <i>Why choose Lisa</i>                                        |
| <b>12</b> | <b>Moduli singoli, Linea Okinawa e Isole</b> // <i>Single units, Okinawa line and Islands</i> |
| <b>14</b> | <b>Moduli Singoli</b> // <i>Single units</i>                                                  |
| 16        | Giglio - Giudecca                                                                             |
| 17        | Murano - Burano                                                                               |
| 18        | Giglio 90 BBQ - Giglio 120 BBQ                                                                |
| <b>20</b> | <b>Linea Okinawa</b> // <i>Okinawa line</i>                                                   |
| 22        | Okinawa 60                                                                                    |
| 23        | Okinawa 120 Sportelli - Okinawa 120 Cassetti                                                  |
| 24        | Okinawa 120 Sportelli e cassetti                                                              |
| 25        | Okinawa 150 Sportelli - Okinawa 150 Cassetti                                                  |
| 26        | Okinawa 180 Sportelli - Okinawa 180 Sportelli e cassetti                                      |
| <b>28</b> | <b>Isole</b> // <i>Islands</i>                                                                |
| 30        | Panarera                                                                                      |
| 31        | Panarera BBQ                                                                                  |
| 32        | Lipari                                                                                        |
| 33        | Lipari BBQ                                                                                    |
| 34        | Capri                                                                                         |
| 35        | Capri BBQ                                                                                     |
| 36        | Capri BBQ Kamado Sportelli - Capri BBQ Kamado Sportelli e cassetti                            |
| 37        | Ischia                                                                                        |
| 38        | Ischia BBQ                                                                                    |
| 39        | Ischia BBQ Kamado Sportelli - Ischia BBQ Kamado Sportelli e cassetti                          |
| <b>40</b> | <b>Outdoor kitchen personalizzate</b> // <i>Customized Outdoor Kitchen</i>                    |
| <b>42</b> | <b>Come personalizzare la tua cucina</b> // <i>How to customize your kitchen</i>              |
| <b>44</b> | <b>Linea Elba</b> // <i>Elba Line</i>                                                         |
| 46        | Moduli 45 cm // <i>17 6/8 in units</i>                                                        |
| 47        | Moduli 60 cm // <i>23 3/5 in units</i>                                                        |
| 48        | Moduli 90 cm // <i>35 2/5 in units</i>                                                        |
| 49        | Moduli 120 cm // <i>42 1/4 in units</i>                                                       |
| <b>50</b> | <b>Linea Pantelleria</b> // <i>Pantelleria Line</i>                                           |
| 52        | Moduli 45 cm // <i>17 6/8 in units</i>                                                        |
| 53        | Moduli 60 cm // <i>23 3/5 in units</i>                                                        |
| 54        | Moduli 90 cm // <i>35 2/5 in units</i>                                                        |
| 55        | Moduli 120 cm // <i>42 1/4 in units</i>                                                       |
| <b>56</b> | <b>Accessori</b> // <i>Accessories</i>                                                        |
| 58        | Lavelli saldati & Miscelatori // <i>Welded sink &amp; Mixer taps</i>                          |
| 59        | Piani cottura stand alone & Barbecue a gas // <i>Stand alone hobs &amp; Gas barbecue</i>      |
| 60        | Sedute & piedi // <i>Seats &amp; legs</i>                                                     |
| 61        | Finiture // <i>Finishes</i>                                                                   |
| <b>62</b> | <b>Note</b> // <i>Notes</i>                                                                   |

## DA 18 ANNI LA QUALITÀ AL PRIMO POSTO

Presente dal **2004** nel mercato della trasformazione dell'acciaio con le migliori tecnologie, arricchite dal know-how acquisito con la realizzazione di arredamenti per marchi prestigiosi.

Da sempre attenta al design e alla funzionalità dei prodotti, attraverso la ricerca di linee moderne e la cura dei particolari.

La sua mission aziendale è offrire ai clienti un elevato livello qualitativo dei prodotti, nel rispetto di un target di prezzo. Questo grazie ad un investimento costante e continuo su tecnologie sempre aggiornate, ad un team di collaboratori di riconosciuta professionalità, competenza ed esperienza.

Dal 2020 il ciclo produttivo è completamente alimentato da energia pulita.

## *SINCE 18 YEARS, QUALITY IN FIRST PLACE*

*Active since **2004** in the steel transformation market with the best technologies, enriched by the know-how acquired through the production of furnishings for prestigious brands. Always focussed on the design and functionality of its products, through the search for modern lines and attention to details.*

*Its mission is to offer customers a high level product quality, respecting a price target. This is thanks to a constant and continuous investment in up-to-date technologies and to a team of collaborators of recognised professionalism, competence and experience.*

*Since 2020 the production cycle has been completely powered by clean energy.*





## L' OUTDOOR KITCHEN, DA SOGNO A REALTÀ

La vision aziendale è offrire una soluzione compatibile con gli spazi a disposizione e che soddisfi le necessità richieste dalla zona outdoor.

I prodotti a catalogo, rigorosamente made in Italy, contraddistinti dalla cura dei dettagli e dalla scelta di componenti di prima qualità, si suddividono in tre categorie: moduli singoli, isole personalizzate e outdoor kitchen personalizzate. I moduli singoli sono prodotti indirizzati a coloro che cercano una soluzione compatta e dinamica, un concentrato di qualità su ruote posizionabile in 64cm di spazio.

Le isole outdoor sono prodotti di circa 180 cm, con un lavello e un piano cottura, indirizzati a coloro che hanno bisogno di una soluzione pronta all'uso, qualitativamente elevata e sviluppata per impreziosire la propria area outdoor living.

Nella categoria outdoor kitchen personalizzate rientrano un insieme di prodotti modulari che permettono di sviluppare da zero la cucina outdoor su misura, dipingendola nella propria zona outdoor, come un pittore su una tela bianca.

## OUTDOOR KITCHEN, FROM DREAM TO REALITY

*The company vision is to offer a solution that is compatible with the available space and fulfils the needs of the outdoor area.*

*The products in the catalogue, rigorously made in Italy, characterised by attention to detail and the choice of top quality components, are divided into three categories: single modules, customized islands and customized outdoor kitchens. The single units are products aimed at those seeking a compact and dynamic solution, a concentrate of quality on wheels that can be positioned in 64 cm of space.*

*The outdoor islands are products of approximately 180 cm, with a sink and hob, addressed to those who need a ready-to-use, high quality solution developed to embellish their outdoor living area.*

*The customized outdoor kitchen category includes a set of modular products that allow you to develop your own customized outdoor kitchen from scratch, painting it into your outdoor area, like a painter on a blank canvas.*







## CUCINE NATE FORTI E GENTILI

I nostri prodotti nascono circondati dalla bellezza.

Nascono protetti dalla forza degli appennini abruzzesi e accarezzati con gentilezza delle onde della costa adriatica.

E da qui, dal nostro stabilimento di Pescara, che il design delle nostre produzioni viene contaminato dalle caratteristiche del nostro territorio. La forza e la stabilità delle strutture in acciaio, rifinite nei minimi particolari abbracciano la gentilezza delle linee, la dolcezza delle chiusure e l'armonia dei dettagli.

Un risultato finale che trasmette l'amore per la propria terra, l'attenzione nel proprio lavoro richiamando alla memoria la bellezza delle lavorazioni artigianali proprie del made in italy nella sua accezione originale del termine.





## ***KITCHEN BORN “STRONG AND GENTLE”***

*Our products are born surrounded by beauty.*

*They are born protected by the strength of the Abruzzo Apennines and gently caressed by the waves of the Adriatic coast.*

*And it is from here, from our factory in Pescara, that the design of our products is contaminated by the characteristics of our land. The strength and stability of the steel structures, finished to the smallest detail, embrace the gentleness of the lines, the softness of the closures and the harmony of the details.*

*An end result that conveys the love for one's land, the care in one's work, recalling the beauty of craftsmanship typical of Made in Italy in its original meaning of the term.*



## PERCHE' SCEGLIERE LISA

I moduli singoli, le isole outdoor e le cucine personalizzate presentano, nella loro composizione, alcuni dettagli importanti che contribuiscono a elevarne la qualità e l'estetica.

Una delle caratteristiche che accomuna tutti i prodotti della Lisa è la presenza di guide e di cerniere della Blum, marchio leader nella produzione di sistemi di chiusura per ante e cassetti di qualità elevata.

Tutte le guide e cerniere della Blum scelte sono dotate di sistema di ammortizzazione adattivo Bluemotion e grazie alla qualità indiscussa delle guide i cassetti raggiungono la portata di 30kg e i cassettoni quella di 65kg.

Tutte le cucine sono rifinite internamente anche nelle ante e nei cassetti.

## WHY CHOOSE LISA

*The single units, the outdoor islands and the customized kitchens have some important features in their composition that contribute to enhancing their quality and aesthetics.*

*One of this, which all Lisa's products have in common, is the use of guides and hinges by Blum, a leading brand in the production of high- quality door and drawer closing systems.*

*All chosen Blum guides and hinges are equipped with the Bluemotion adaptive damping system, and thanks to the undisputed quality of the guides the drawers reach a load capacity of 30kg and the pull-outs that of 65kg.*

*All kitchens are also internally finished in the doors and drawers.*







*MODULI SINGOLI, LINEA OKINAWA E ISOLE //  
SINGLE UNITS, OKINAWA LINE AND ISLANDS*



MODULI SINGOLI, LINEA OKINAWA E ISOLE // SINGLE UNITS, OKINAWA LINE AND ISLANDS

# MODULI SINGOLI



Componenti d'arredo pronti a soddisfare ogni esigenza.

I moduli hanno fianchi e top slim che, insieme alle ante con gola, conferiscono carattere ed eleganza.

Disponibili in varie configurazioni, facilmente collocabili e adatti ad ogni tipo di richiesta.

Dotati di ruote per facilitarne lo spostamento.

*Furniture components ready to meet every need.*

*The modules have slim sides and tops which, together with the doors with grooves, lend character and elegance.*

*Available in various configurations, they are easy to place and suitable for every requirement.*

*Equipped with wheels for easy movement.*

**Colori disponibili per tutte le versioni // Available colors for all versions**

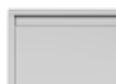

ACCIAIO //  
BRUSHED STAINLESS  
STEEL



ANTRACITE //  
ANTHRACITE  
RAL 9004

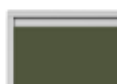

VERDE //  
GREEN  
RAL 6003

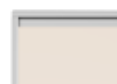

BIANCO //  
WHITE  
RAL 9001





**COD OUT001 - GIGLIO**

- Modulo da 64 x 70 cm in acciaio inox 430 scotch brite con un'anta.
  - Top alto 2 cm in acciaio inox 304.
  - Sistema di apertura con Gola.
  - Anta con sistema di ammortizzazione adattivo Bluemotion.
  - Quattro ruote piroettanti di cui due frontali con freno.
  - Disponibile in tre configurazioni.
- *25 1/4 x 27 1/2 in module in 430 scotch brite stainless steel with one door.*
  - *4/5 inches high 304 stainless steel top.*
  - *Opening system with recessed grip profile*
  - *Door with Bluemotion adaptive damping system.*
  - *Four swivel castors, two of which at the front with brakes.*
  - *Available in three configurations.*



**COD OUT002 - GIUDECCA**

- Modulo da 64 x 70 cm in acciaio inox 430 scotch brite con due cassettoni.
  - Top alto 2 cm in acciaio inox 304.
  - Sistema di apertura con Gola.
  - Cassettoni di 357 mm di altezza con sistema di ammortizzazione adattivo Bluemotion della portata di 65 kg .
  - Quattro ruote piroettanti di cui due frontali con freno.
  - Disponibile in due configurazioni.
- *25 1/4x27 1/2 in module in 430 scotch brite stainless steel with two drawers.*
  - *4/5 inches high 304 stainless steel top.*
  - *Opening system with recessed grip profile.*
  - *357 mm deep drawer with 65 kg capacity Bluemotion adaptive damping system.*
  - *Four swivel castors, two of which are front wheels with brakes.*
  - *Available in two configurations.*





**COD OUT003 - MURANO**



- Modulo da 64 x 70 cm in acciaio inox 430 scotch brite con due cassetti, un cassettone e top alto 2 cm in acciaio inox 304.
- Sistema di apertura con Gola.
- Cassettone di 357mm di altezza e 65 kg di portata e cassetti di 177mm di altezza e 30 kg di portata con sistema di ammortizzazione adattivo Bluemotion.
- Quattro ruote piroettanti di cui due frontali con freno.
- Disponibile in due configurazioni.

- *25 1/4 x 27 1/2 in module in 430 scotch brite stainless steel with two drawers and one deep drawer*
- *4/5 inches high 304 stainless steel top.*
- *Opening system with recessed grip profile.*
- *Drawer 357 mm high and 65 kg capacity and drawers 177 mm high and 30 kg capacity with Bluemotion adaptive damping system.*
- *Four swivel castors, two of which are front wheels with brakes.*
- *Available in two configurations.*

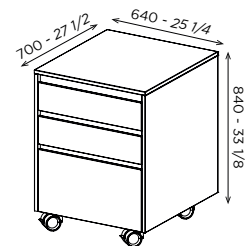

**COD OUT004 - BURANO**



- Modulo da 64 x 70 cm in acciaio inox 430 scotch brite con quattro cassetti e top alto 2 cm in acciaio inox 304.
- Sistema di apertura con Gola.
- Cassetti di 177mm di altezza con sistema di ammortizzazione adattivo Bluemotion con portata di 30 kg.
- Quattro ruote piroettanti di cui due frontali con freno.
- Disponibile in due configurazioni.

- *25 1/4x27 1/2 in module in 430 scotch brite stainless steel with four drawers.*
- *4/5 inches high 304 stainless steel top.*
- *Opening system with recessed grip profile.*
- *Drawers 177 mm high with Bluemotion adaptive damping system with 30 kg capacity.*
- *Four swivel castors, two of which are front wheels with brakes.*
- *Available in two configurations.*

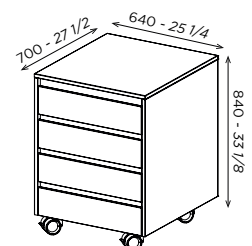



**COD OUT011BF - GIGLIO 90 BBQ**

- Modulo Giglio BBQ da 94 x 70 cm in acciaio inox 430 scotch brite con due ante e top alto 2 cm in acciaio inox 304.
- Sistema di apertura con Gola.
- Ante con sistema di ammortizzazione adattivo Bluemotion
- Quattro ruote piroettanti di cui due frontali con freno.
- Barbecue a gas da incasso Fogher. Il barbecue ha due bruciatori da 2,5 Kw l'uno, una griglia di cottura e una piastra in acciaio inox.

- *Giglio BBQ module 37 x 27 1/2 inches in 430 scotch brite stainless steel with two doors and top 4/5 inches high in 304 stainless steel.*
- *Opening system with recessed grip profile.*
- *Doors with Bluemotion adaptive damping system*
- *Four swivel castors, two of which at the front with brake.*
- *Fogher built-in gas barbecue. The barbecue has two burners of 2.5 Kw each, a cooking grid and a stainless steel plate.*

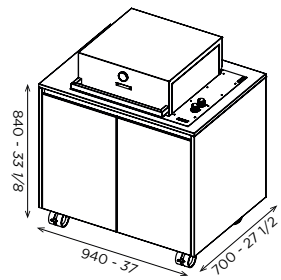

**COD OUT012BF - GIGLIO 120 BBQ**

- Modulo Giglio BBQ da 124 x 70 cm in acciaio inox 430 scotch brite con due ante e top alto 2 cm in acciaio inox 304.
- Sistema di apertura con Gola.
- Ante con sistema di ammortizzazione adattivo Bluemotion
- Quattro ruote piroettanti di cui due frontali con freno.
- Barbecue a gas da incasso Fogher. Il barbecue ha due bruciatori da 2,5 Kw l'uno, una griglia di cottura e una piastra in acciaio inox.

- *Giglio BBQ module 48 7/8 x 27 1/2 inches in 430 scotch brite stainless steel with two doors and top 4/5 inches high in 304 stainless steel.*
- *Opening system with recessed grip profile.*
- *Doors with Bluemotion adaptive damping system*
- *Four swivel castors, two of which at the front with brake.*
- *Fogher built-in gas barbecue. The barbecue has two burners of 2.5 Kw each, a cooking grid and a stainless steel plate.*

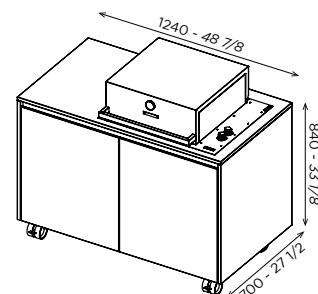





MODULI SINGOLI, LINEA OKINAWA E ISOLE // SINGLE UNITS, OKINAWA LINE AND ISLANDS

# LINEA OKINAWA

La linea Okinawa prende nome dall'omonima isola del Giappone.

Tutti i modelli della linea sono nati per integrare e sorreggere barbecue della tipologia Kamado, tipico barbecue a carbone di origini nipponiche.

Nella linea sono disponibili otto modelli, dal modulo singolo di 64 cm di larghezza all'isola di 184 cm.

The Okinawa line takes its name from the homonymous island in Japan.

All the models in the line were created to integrate and support Kamado type barbecues, a typical charcoal barbecue of Japanese origins.

Eight models are available in the line, from the single 25,20 inches wide module to the 72,44 inches island.

## Fori disponibili // Available holes



## Mensola regolabile in altezza // Support shelf adjustable

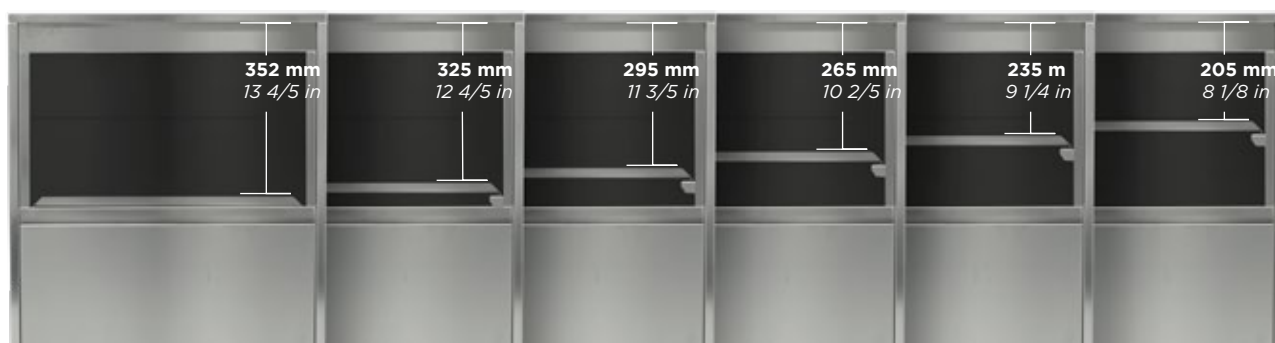

## Colori disponibili // Available colors



ACCIAIO // BRUSHED STAINLESS STEEL

ANTRACITE // ANTHRACITE RAL 9004

VERDE // GREEN RAL 6003

BIANCO // WHITE RAL 9001





### COD OUT013 - OKINAWA 60

- Modulo da 64 x 70 cm in acciaio inox 430 scotch brite con un cassettone.
- Top alto 2 cm in acciaio inox 304.
- Sistema di apertura con Gola.
- Cassettone di 357 mm di altezza con sistema di ammortizzazione adattivo Bluemotion della portata di 65 kg.
- Foro per inserimento kamado disponibile in quattro diametri diversi.
- Mensola di appoggio kamado regolabile in cinque altezze diverse.
- Quattro ruote piroettanti di cui due frontali con freno.

- 25 1/4 x 27 1/2 inches module in 430 scotch brite stainless steel with one deep drawer
- 4/5 inches high 304 stainless steel top.
- Opening system with recessed grip profile.
- Drawer 14 inches high and 65 kg capacity with Bluemotion adaptive damping system.
- Hole for kamado insertion available in four different diameters.
- Kamado support shelf adjustable to five different heights.
- Four swivel castors, two of which are front wheels with brakes.

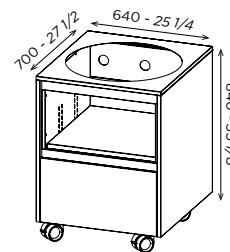



### COD OUT014\_S - OKINAWA 120 SPORTELLO

- Modulo da 124 x 70 cm in acciaio inox 430 scotch brite.
- Top alto 2 cm in acciaio inox 304.
- Sistema di apertura con Gola.
- Un cassettone e un anta con sistema di ammortizzazione adattivo Bluemotion.
- Foro per inserimento kamado disponibile in quattro diametri diversi.
- Mensola di appoggio kamado regolabile in cinque altezze diverse.
- Sei ruote piroettanti di cui due frontali con freno.

- 48 7/8 x 27 1/2 inches module in 430 scotch brite stainless steel.
- 4/5 inches high 304 stainless steel top.
- Opening system with recessed grip profile.
- A deep drawer and a door with Bluemotion adaptive damping system.
- Hole for kamado insertion available in four different diameters.
- Kamado support shelf adjustable to five different heights.
- Six swivel castors, two of which are front wheels with brakes.

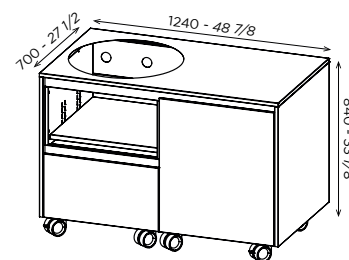

### COD OUT014\_C - OKINAWA 120 CASSETTI

- Modulo da 124 x 70 cm in acciaio inox 430 scotch brite.
- Top alto 2 cm in acciaio inox 304.
- Sistema di apertura con Gola.
- Due cassettoni e due cassetti con sistema di ammortizzazione adattivo Bluemotion.
- Foro per inserimento kamado disponibile in quattro diametri diversi.
- Mensola di appoggio kamado regolabile in cinque altezze diverse.
- Sei ruote piroettanti di cui due frontali con freno.

- 48 7/8 x 27 1/2 inches module in 430 scotch brite stainless steel.
- 4/5 inches high 304 stainless steel top.
- Opening system with recessed grip profile.
- Two deep drawers and two drawers with Bluemotion adaptive damping system.
- Hole for kamado insertion available in four different diameters.
- Kamado support shelf adjustable to five different heights.
- Six swivel castors, two of which are front wheels with brakes.

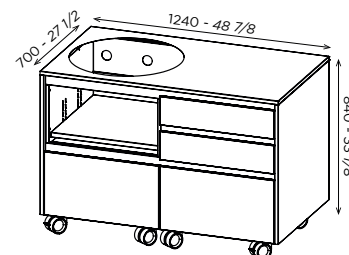



### COD OUT015\_CS - OKINAWA 150 SPORTELLI E CASSETTI

- Modulo da 154 x 70 cm in acciaio inox 430 scotch brite.
- Top alto 2 cm in acciaio inox 304.
- Sistema di apertura con Gola.
- Due cassettoni, due cassetti e un anta con sistema di ammortizzazione adattivo Bluemotion.
- Foro per inserimento kamado disponibile in quattro diametri diversi.
- Mensola di appoggio kamado regolabile in cinque altezze diverse.
- Otto ruote piroettanti di cui due frontali con freno.

- 60 3/5 x 27 1/2 inches module in 430 scotch brite stainless steel.
- 4/5 inches high 304 stainless steel top.
- Opening system with recessed grip profile.
- Two deep drawers, two drawers and a door with Bluemotion adaptive damping system.
- Hole for kamado insertion available in four different diameters.
- Kamado support shelf adjustable to five different heights.
- Eight swivel castors, two of which are front wheels with brakes.

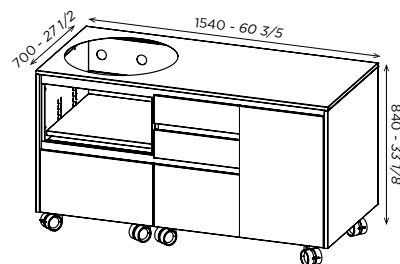





### COD OUT015\_S - OKINAWA 150 SPORTELLI

- Modulo da 154 x 70 cm in acciaio inox 430 scotch brite.
- Top alto 2 cm in acciaio inox 304.
- Sistema di apertura con Gola.
- Un cassetto e due ante con sistema di ammortizzazione adattivo Bluemotion.
- Foro per inserimento kamado disponibile in quattro diametri diversi.
- Mensola di appoggio kamado regolabile in cinque altezze diverse.
- Otto ruote piroettanti di cui due frontali con freno.

- *60 3/5 x 27 1/2 inches module in 430 scotch brite stainless steel.*
- *4/5 inches high 304 stainless steel top.*
- *Opening system with recessed grip profile.*
- *A deep drawer and two doors with Bluemotion adaptive damping system.*
- *Hole for kamado insertion available in four different diameters.*
- *Kamado support shelf adjustable to five different heights.*
- *Eight swivel castors, two of which are front wheels with brakes.*

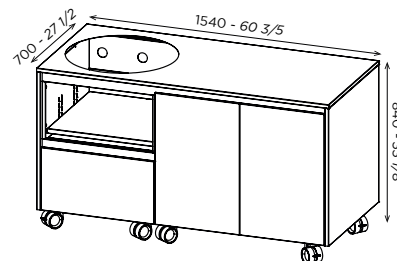

### COD OUT015\_C - OKINAWA 150 CASSETTI

- Modulo da 154 x 70 cm in acciaio inox 430 scotch brite.
- Top alto 2 cm in acciaio inox 304.
- Sistema di apertura con Gola.
- Due cassettoni e due cassetti con sistema di ammortizzazione adattivo Bluemotion.
- Foro per inserimento kamado disponibile in quattro diametri diversi.
- Mensola di appoggio kamado regolabile in cinque altezze diverse.
- Otto ruote piroettanti di cui due frontali con freno.

- *60 3/5 x 27 1/2 inches module in 430 scotch brite stainless steel.*
- *4/5 inches high 304 stainless steel top.*
- *Opening system with recessed grip profile.*
- *Two deep drawers and two drawers with Bluemotion adaptive damping system.*
- *Hole for kamado insertion available in four different diameters.*
- *Kamado support shelf adjustable to five different heights.*
- *Eight swivel castors, two of which are front wheels with brakes.*

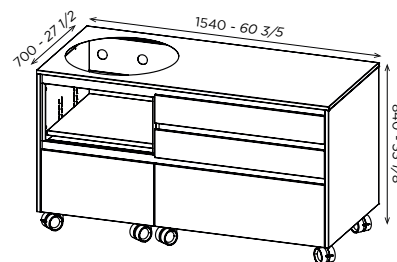



**COD OUT016\_S - OKINAWA 180 SPORTELLI**

- Modulo da 184 x 70 cm in acciaio inox 430 scotch brite.
- Top alto 2 cm in acciaio inox 304.
- Sistema di apertura con Gola.
- Due cassettoni, due cassetti e un anta con sistema di ammortizzazione adattivo Bluemotion.
- Foro per inserimento kamado disponibile in quattro diametri diversi.
- Mensola di appoggio kamado regolabile in cinque altezze diverse.
- Otto ruote piroettanti di cui due frontali con freno.

- *72 1/2 x 27 1/2 inches module in 430 scotch brite stainless steel.*
- *4/5 inches high 304 stainless steel top.*
- *Opening system with recessed grip profile.*
- *Two deep drawers, two drawers and a door with Bluemotion adaptive damping system.*
- *Hole for kamado insertion available in four different diameters.*
- *Kamado support shelf adjustable to five different heights.*
- *Eight swivel castors, two of which are front wheels with brakes.*

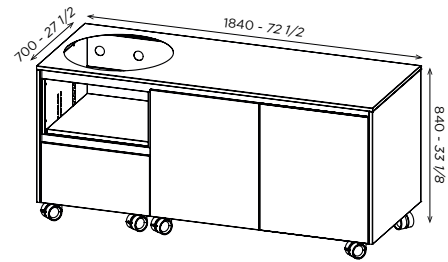

**COD OUT016\_CS - OKINAWA 180 SPORTELLI E CASSETTI**

- Modulo da 184 x 70 cm in acciaio inox 430 scotch brite.
- Top alto 2 cm in acciaio inox 304.
- Sistema di apertura con Gola.
- Un cassettone e due ante con sistema di ammortizzazione adattivo Bluemotion.
- Foro per inserimento kamado disponibile in quattro diametri diversi.
- Mensola di appoggio kamado regolabile in cinque altezze diverse.
- Otto ruote piroettanti di cui due frontali con freno.

- *72 1/2 x 27 1/2 inches module in 430 scotch brite stainless steel.*
- *4/5 inches high 304 stainless steel top.*
- *Opening system with recessed grip profile.*
- *A deep drawer and two doors with Bluemotion adaptive damping system.*
- *Hole for kamado insertion available in four different diameters.*
- *Kamado support shelf adjustable to five different heights.*
- *Eight swivel castors, two of which are front wheels with brakes.*

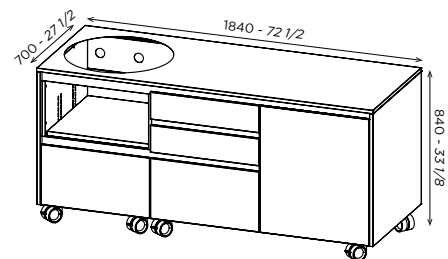





# ISOLE



Nelle isole outdoor si aggiunge alla versione con ante a gola, una soluzione dal design minimalista senza maniglie.

E' possibile scegliere tra una configurazione con top e fianchi slim e una con fianco strong e top con snack.

Una proposta compatta dotata di un lavello e un piano cottura domino.

Dotata di sei ruote per facilitarne lo spostamento.

Disponibile in quattro versioni.

*In addition to the version with groove doors, the outdoor islands offer a minimalist design solution without handles.*

*It is possible to choose between a configuration with slim top and sides and one with strong side and top with snack.*

*A compact proposal equipped with a sink and a domino hob. Equipped with six wheels for easy movement.*

*Available in four versions.*

**Colori disponibili per tutte le versioni // Available colors for all versions**



ACCIAIO //  
BRUSHED STAINLESS  
STEEL



ANTRACITE //  
ANTHRACITE  
RAL 9004

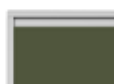

VERDE //  
GREEN  
RAL 6003

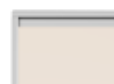

BIANCO //  
WHITE  
RAL 9001





## COD OUT005 - PANAREA

- Isola da 188 x 100 cm in acciaio inox 430 scotch brite.
- Top con snack alto 4 cm in acciaio inox 304.
- Lavello saldato a filo top.
- Sistema di apertura con Gola.
- Quattro cassetti da 177 mm di altezza e portata 30 kg, due cassettoni da 357 mm e portata 65 kg e un'anta.
- Cassetti e sportello con sistema di ammortizzazione adattivo Bluemotion.
- Sei ruote piroettanti di cui due con freno.
- Disponibile in tre configurazioni.

- 74 x 39 3/8 inches island in stainless steel 430 scotch brite.
- Top with 1 1/2 inches high snacks in 304 stainless steel.
- Flush welded sink top.
- Opening system with recessed grip profile.
- Four 7 inches high drawers with 30 kg capacity, two 14 inches high drawers with 65 kg capacity and one door.
- Drawers and door with Bluemotion adaptive damping system.
- Six swivel castors, two with brakes.
- Available in three configurations.

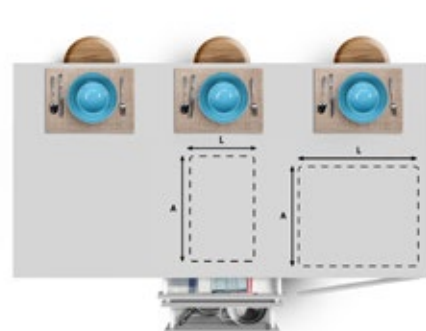
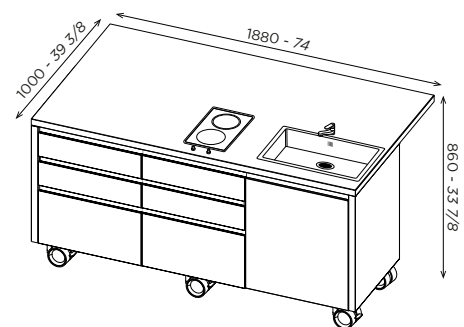

**COD OUT005L5**  
PANAREA SOLO LAVELLO //  
PANAREA WITH SINK ONLY

**COD OUT005PN**  
PANAREA PIANO //  
PANAREA WORKTOP

**COD OUT005PR**  
PANAREA PERSONALIZZABILE //  
CUSTOMIZABLE PANAREA





### COD OUT005BF - PANAREA BBQ

- Isola da 188 x 100 cm in acciaio inox 430 scotch brite.
- Top con snack alto 4 cm in acciaio inox 304.
- Lavello saldato a filo top.
- Sistema di apertura con Gola.
- Tre ante da 60 cm di larghezza con sistema di ammortizzazione adattivo Bluemotion.
- Sei ruote piroettanti di cui due con freno.
- Disponibile con barbecue a gas Fogher. Il barbecue ha due bruciatori da 2,5 Kw l'uno, una griglia di cottura e una piastra in acciaio inox.

- 74 x 39 3/8 inches island in stainless steel 430 scotch brite.
- Top with 1 1/2 inches high snack in 304 stainless steel.
- Flush welded sink top.
- Opening system with recessed grip profile.
- Three 23 3/5 inches wide doors with Bluemotion adaptive damping system.
- Six swivel castors, two of which have brakes.
- Available with Fogher gas barbecue. The barbecue has two burners of 2.5 Kw each, a cooking grid and a stainless steel plate.

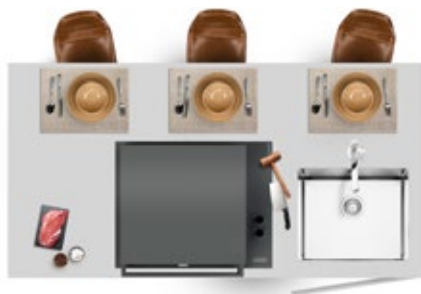
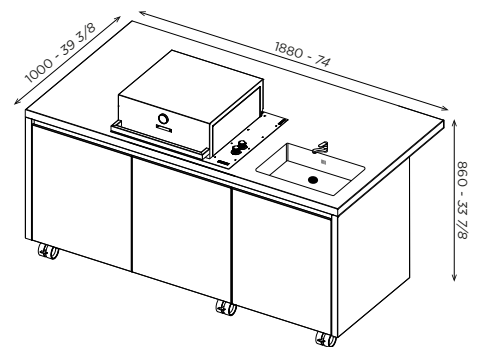



## COD OUT006 - LIPARI

- Isola da 188 x 100 cm in acciaio inox 430 scotch brite.
- Top con snack alto 4 cm in acciaio inox 304.
- Lavello saldato a filo top.
- Sistema di apertura con Tip-on e Bluemotion.
- Quattro cassetti da 177 mm di altezza e portata 30 kg, due cassettoni da 357 mm e portata 65 kg e un'anta.
- Sei ruote piroettanti di cui due con freno.
- Disponibile in tre configurazioni.

- 74 x 39 3/8 inches island in stainless steel 430 scotch brite.
- Top with 1 1/2 inches high snacks in 304 stainless steel.
- Flush welded sink top.
- Tip-on and Bluemotion opening system.
- Four drawers with a height of 7 inches and a load capacity of 30kg, two deep drawers with a height of 14 inches and a load capacity of 65 kg, and one door.
- Six swivel castors, two with brakes.
- Available in three configurations.

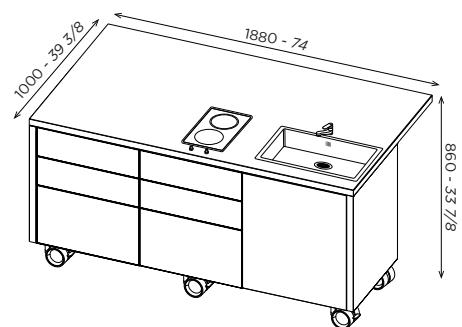
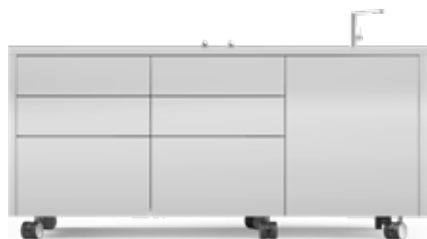

**COD OUT006LS**  
LIPARI SOLO LAVELLO //  
LIPARI WITH SINK ONLY

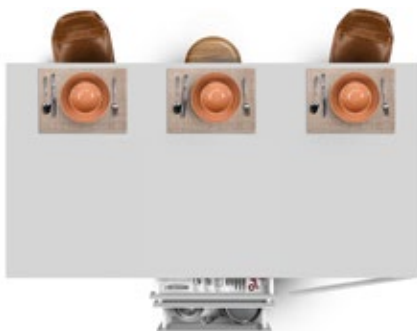

**COD OUT006PN**  
LIPARI PIANO //  
LIPARI WORKTOP

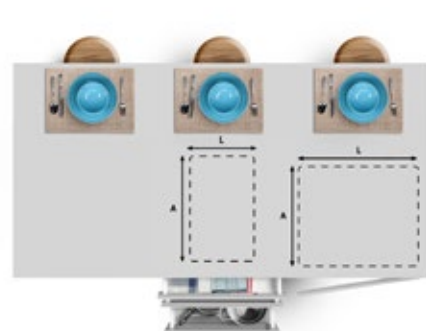

**COD OUT006PR**  
LIPARI PERSONALIZZABILE //  
CUSTOMIZABLE LIPARI







## COD OUT006BF - LIPARI BBQ

- Isola da 188 x 100 cm in acciaio inox 430 scotch brite.
- Top con snack alto 4 cm in acciaio inox 304.
- Lavello saldato a filo top.
- Tre ante da 60 cm di larghezza con apertura Tip-on e sistema di ammortizzazione adattivo Bluemotion.
- Sei ruote piroettanti di cui due con freno.
- Disponibile con barbecue a gas Fogher. Il barbecue ha due bruciatori da 2,5 Kw l'uno, una griglia di cottura e una piastra in acciaio inox.

- 74 x 39 3/8 inches island in stainless steel 430 scotch brite.
- Top with 1 1/2 inches high snacks in 304 stainless steel.
- Flush welded sink top.
- Three 23 3/5 inches wide doors with tip-on opening and Bluemotion adaptive damping system.
- Six swivel castors, two of which have brakes.
- Available with Fogher gas barbecue. The barbecue has two burners of 2.5 Kw each, a cooking grid and a stainless steel plate.

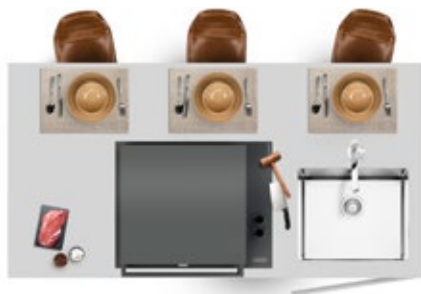
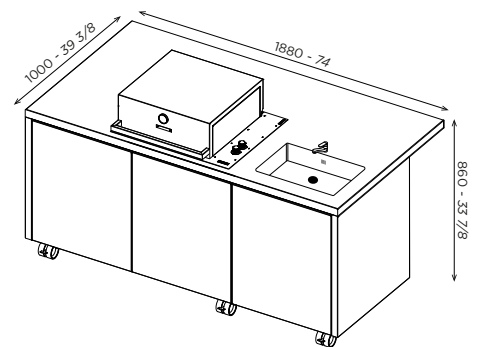



## COD OUT007 - CAPRI

- Isola da 184 x 70 cm in acciaio inox 430 scotch brite.
  - Top alto 2 cm in acciaio inox 304.
  - Lavello saldato a filo top.
  - Sistema di apertura con Gola.
  - Quattro cassetti da 177 mm di altezza e portata 30 kg, due cassettoni da 357 mm e portata 65 kg e un'anta.
  - Cassetti e sportello con sistema di ammortizzazione adattivo Bluemotion.
  - Sei ruote piroettanti di cui due con freno.
  - Disponibile in tre configurazioni.
- 72 1/2 x 27 1/2 inches island in stainless steel 430 scotch brite.
  - Top with 4/5 inches high snacks in 304 stainless steel.
  - Flush welded sink top.
  - Opening system with recessed grip profile.
  - Four 7 inches high drawers with 30 kg capacity, two 14 inches high drawers with 65 kg capacity and one door.
  - Drawers and door with Bluemotion adaptive damping system.
  - Six swivel castors, two with brakes.
  - Available in three configurations.

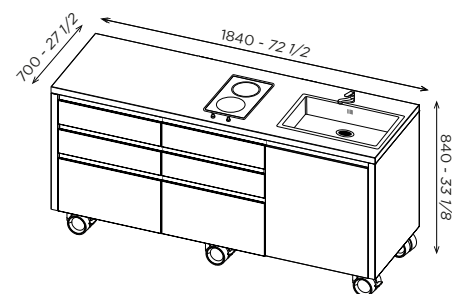
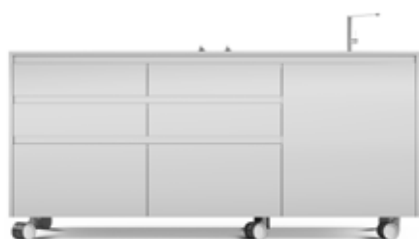

**COD OUT007L5**  
CAPRI SOLO LAVELLO //  
CAPRI WITH SINK ONLY

**COD OUT007PN**  
CAPRI PIANO //  
CAPRI WORKTOP

**COD OUT007PR**  
CAPRI PERSONALIZZABILE //  
CUSTOMIZABLE CAPRI





## COD OUT007BF - CAPRI BBQ

- Isola da 184 x 70 cm in acciaio inox 430 scotch brite.
- Top alto 2 cm in acciaio inox 304.
- Lavello saldato a filo top.
- Sistema di apertura con Gola.
- Tre ante da 60 cm di larghezza con sistema di ammortizzazione adattivo Bluemotion.
- Sei ruote piroettanti di cui due con freno.
- Disponibile con barbecue a gas Fogher. Il barbecue ha due bruciatori da 2,5 Kw l'uno, una griglia di cottura e una piastra in acciaio inox.

- 72 1/2 x 27 1/2 inches island in 430 scotch brite stainless steel.
- Top 4/5 inches high in 304 stainless steel.
- Flush welded sink.
- Opening system with recessed grip profile.
- Three 23 3/5 inches wide doors with Bluemotion adaptive damping system.
- Six swivel castors, two of which have brakes.
- Available with Fogher gas barbecue. The barbecue has two burners of 2.5 Kw each, a cooking grid and a stainless steel plate.

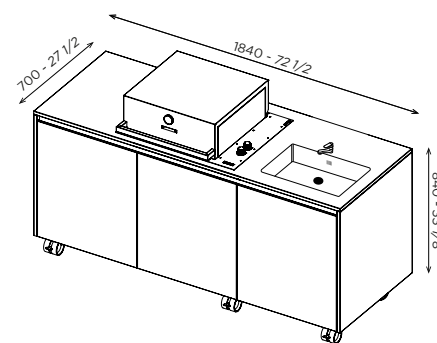
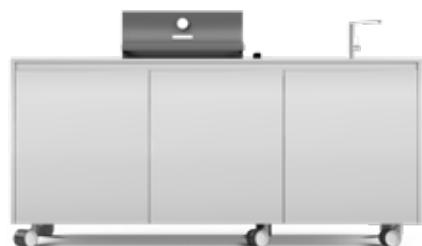



### COD OUT007BK\_S - CAPRI BBQ KAMADO SPORTELLI

- Modulo da 184 x 70 cm in acciaio inox 430 scotch brite.
- Top alto 2 cm in acciaio inox 304.
- Sistema di apertura con Gola.
- Un cassettono e due ante con sistema di ammortizzazione adattivo Bluemotion e lavello in acciaio saldato.
- Foro per inserimento kamado disponibile in quattro diametri diversi.
- Mensola di appoggio kamado regolabile in cinque altezze diverse.
- Otto ruote piroettanti di cui due frontali con freno.

- *72 1/2 x 27 1/2 inches module in 430 scotch brite stainless steel.*
- *4/5 inches high 304 stainless steel top.*
- *Opening system with recessed grip profile.*
- *A deep drawer and two doors with Bluemotion adaptive damping system and stainless steel welded sink.*
- *Hole for kamado insertion available in four different diameters.*
- *Kamado support shelf adjustable to five different heights.*
- *Eight swivel castors, two of which are front wheels with brakes.*

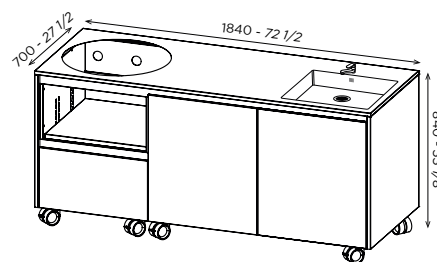

### COD OUT007BK\_CS - CAPRI BBQ KAMADO SPORTELLI E CASSETTI

- Modulo da 184 x 70 cm in acciaio inox 430 scotch brite.
- Top alto 2 cm in acciaio inox 304.
- Sistema di apertura con Gola.
- Due cassettoni, due cassetti e un anta con sistema di ammortizzazione adattivo Bluemotion e lavello in acciaio saldato.
- Foro per inserimento kamado disponibile in quattro diametri diversi.
- Mensola di appoggio kamado regolabile in cinque altezze diverse.
- Otto ruote piroettanti di cui due frontali con freno.

- *72 1/2 x 27 1/2 inches module in 430 scotch brite stainless steel.*
- *4/5 inches high 304 stainless steel top.*
- *Opening system with recessed grip profile.*
- *Two deep drawers, two drawers and a door with Bluemotion adaptive damping system and stainless steel welded sink.*
- *Hole for kamado insertion available in four different diameters.*
- *Kamado support shelf adjustable to five different heights.*
- *Eight swivel castors, two of which are front wheels with brakes.*

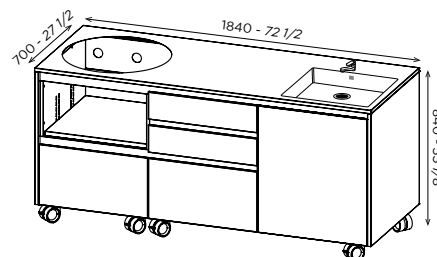



## COD OUT008 - ISCHIA

- Isola da 184 x 70 cm in acciaio inox 430 scotch brite.
  - Top alto 2 cm in acciaio inox 304.
  - Lavello saldato a filo top.
  - Sistema di apertura con Tip-on e Bluemotion.
  - Quattro cassetti da 177 mm di altezza e portata 30 kg, due cassettoni da 357 mm e portata 65 kg e un'anta.
  - Sei ruote piroettanti di cui due con freno.
  - Disponibile in tre configurazioni.
- 72 1/2 x 27 1/2 inches island in stainless steel 430 scotch brite.
  - Top with 4/5 inches high snacks in 304 stainless steel.
  - Flush welded sink top.
  - Tip-on and Bluemotion opening system.
  - Four drawers with a height of 7 inches and a load capacity of 30kg, two deep drawers with a height of 14 inches and a load capacity of 65 kg, and one door.
  - Six swivel castors, two with brakes.
  - Available in three configurations.

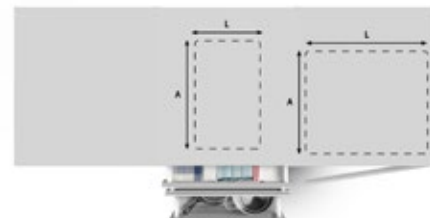
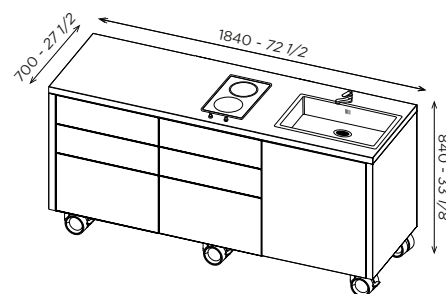

**COD OUT008L5**  
ISCHIA SOLO LAVELLO //  
ISCHIA WITH SINK ONLY

**COD OUT008PN**  
ISCHIA PIANO //  
ISCHIA WORKTOP

**COD OUT008PR**  
ISCHIA PERSONALIZZABILE //  
CUSTOMIZABLE ISCHIA





## COD OUT008BF - ISCHIA BBQ

- Isola da 188 x 100 cm in acciaio inox 430 scotch brite.
- Top con snack alto 4 cm in acciaio inox 304.
- Lavello saldato a filo top.
- Tre ante da 60 cm di larghezza con apertura Tip-on e sistema di ammortizzazione adattivo Bluemotion.
- Sei ruote piroettanti di cui due con freno.
- Disponibile con barbecue a gas Fogher. Il barbecue ha due bruciatori da 2,5 Kw l'uno, una griglia di cottura e una piastra in acciaio inox.

- 72 1/2 x 27 1/2 inches island in stainless steel 430 scotch brite.
- Top with 4/5 inches high snacks in 304 stainless steel.
- Flush welded sink top.
- Three 23 3/5 inches wide doors with tip-on opening and Bluemotion adaptive damping system.
- Six swivel castors, two of which have brakes.
- Available with Fogher gas barbecue. The barbecue has two burners of 2.5 Kw each, a cooking grid and a stainless steel plate.

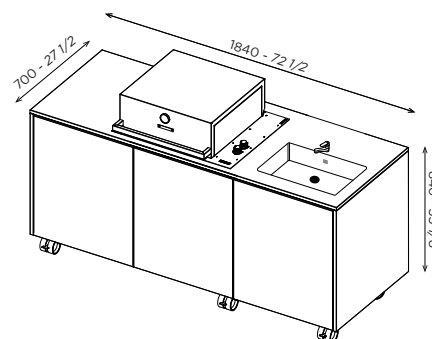



### COD OUT008BK\_S - ISCHIA BBQ KAMADO SPORTELLI

- Modulo da 184 x 70 cm in acciaio inox 430 scotch brite.
- Top alto 2 cm in acciaio inox 304.
- Sistema di apertura con Tip-on.
- Un cassettone e due ante con sistema di ammortizzazione adattivo Bluemotion e lavello in acciaio saldato.
- Foro per inserimento kamado disponibile in quattro diametri diversi.
- Mensola di appoggio kamado regolabile in cinque altezze diverse.
- Otto ruote piroettanti di cui due frontali con freno.

- *72 1/2 x 27 1/2 inches module in 430 scotch brite stainless steel.*
- *4/5 inches high 304 stainless steel top.*
- *Opening system with Tip-on.*
- *A deep drawer and two doors with Bluemotion adaptive damping system and stainless steel welded sink.*
- *Hole for kamado insertion available in four different diameters.*
- *Kamado support shelf adjustable to five different heights.*
- *Eight swivel castors, two of which are front wheels with brakes.*

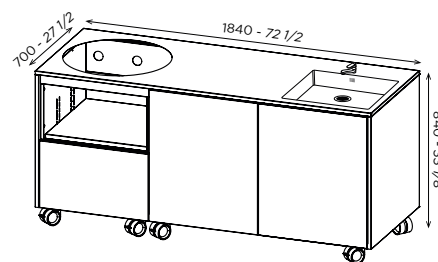

### COD OUT008BK\_CS - ISCHIA BBQ KAMADO SPORTELLI E CASSETTI

- Modulo da 184 x 70 cm in acciaio inox 430 scotch brite.
- Top alto 2 cm in acciaio inox 304.
- Sistema di apertura con Tip-on.
- Due cassettoni, due cassetti e un anta con sistema di ammortizzazione adattivo Bluemotion e lavello in acciaio saldato.
- Foro per inserimento kamado disponibile in quattro diametri diversi.
- Mensola di appoggio kamado regolabile in cinque altezze diverse.
- Otto ruote piroettanti di cui due frontali con freno.

- *72 1/2 x 27 1/2 inches module in 430 scotch brite stainless steel.*
- *4/5 inches high 304 stainless steel top.*
- *Opening system with Tip-on.*
- *Two deep drawers, two drawers and a door with Bluemotion adaptive damping system and stainless steel welded sink..*
- *Hole for kamado insertion available in four different diameters.*
- *Kamado support shelf adjustable to five different heights.*
- *Eight swivel castors, two of which are front wheels with brakes.*

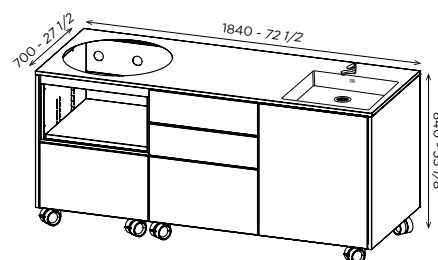



OUTDOOR KITCHEN PERSONALIZZATE //  
CUSTOMIZED OUTDOOR KITCHEN





Con gola o minimale. Con animo fine o con una natura forte. Le scelte che doneranno carattere alla cucina personalizzata partiranno da una idea e, grazie all'aiuto dei nostri designer e al ventaglio di offerte del nostro catalogo, permetteranno di trovare una soluzione cucita sulle esigenze del cliente.

Sviluppiamo il progetto da zero, curandone ogni dettaglio, per arrivare ad una soluzione finale unica.

*With recessed grip profile or minimal. With a fine spirit or with a strong nature. The choices that will give character to the customized kitchen will start with an idea and, with the assistance of our designers and the range of offerings in our catalogue, will lead to a solution tailored to the customer's needs.*

*We develop the project from scratch, taking care of every detail to arrive at a unique final solution.*

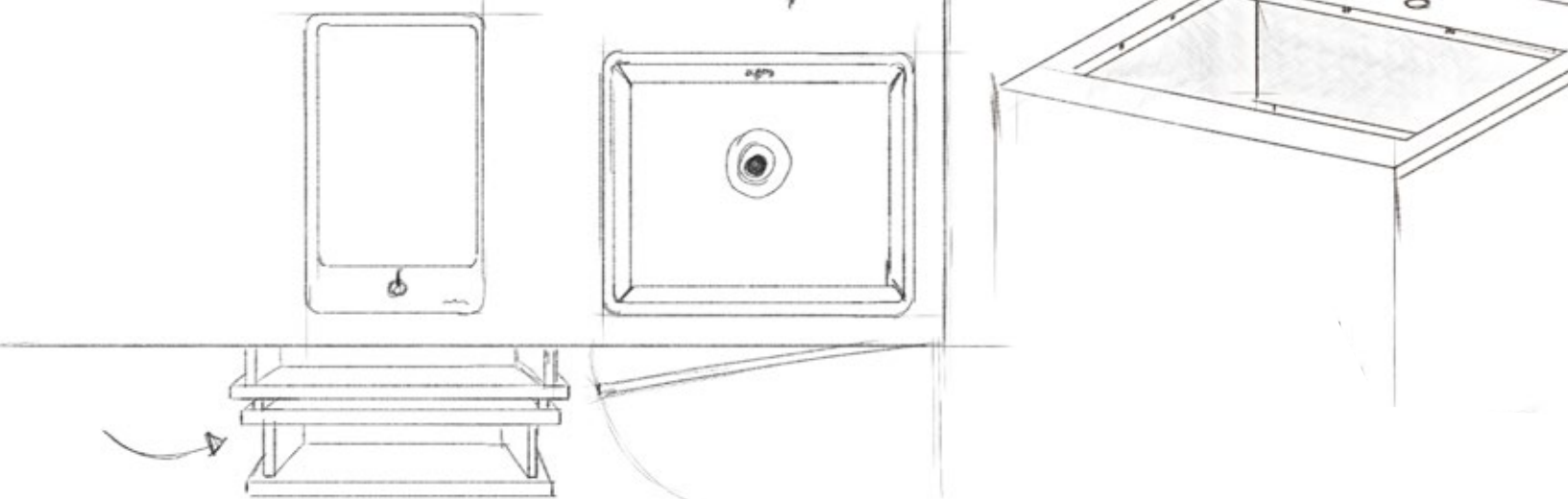

## COME PERSONALIZZARE LA TUA CUCINA

### SCELTA DELLA LINEA (1)

Il primo step per creare la tua cucina outdoor su misura è scegliere la linea che esteticamente e concettualmente ti piace di più.

Le linee disponibili sono **ELBA** e **PANTELLERIA**.

La linea **ELBA** è caratterizzata dal comodo sistema di apertura con gola. Questo sistema dona linearità al frontale della cucina senza perdere la funzionalità di una comoda maniglia. Tutte le ante e i cassetti sono equipaggiati con sistema di ammortizzazione adattivo bluemotion che elimina il rischio di urto anche a seguito delle sollecitazioni più intense.

## HOW TO CUSTOMIZE YOUR KITCHEN

### LINE SELECTION (1)

The first step in creating your custom-made outdoor kitchen is to choose the line that aesthetically and conceptually you like the most. The available lines are **ELBA** and **PANTELLERIA**.

The **ELBA** line is characterised by the handy opening system with recessed grip profile. This system gives linearity to the kitchen front without losing the functionality of a convenient handle. All doors and drawers are equipped with the bluemotion adaptive cushioning system that eliminates the risk of knocks even under the most intense stress.



La linea **PANTELLERIA** ha un design minimale grazie agli sportelli con sistema di apertura tip-on (spingi & apri). Il sistema permette, effettuando una leggera pressione sulla anta o sul cassetto chiuso, che lo sportello si apra automaticamente in modo fluido. Per chiudere basta spingere l'anta, o il cassetto, e questo si chiude dolcemente, grazie al sistema di ammortizzazione adattivo bluemotion integrato.

The **PANTELLERIA** line has a minimalist design with doors featuring a tip-on opening system (push & open). The system allows the door to open automatically and smoothly with a slight pressure on the closed door or drawer. To close, simply push the door, or drawer, and it closes smoothly, thanks to the integrated bluemotion adaptive damping system.



## TOP E FIANCHI (2 & 3)

Dopo aver selezionato la linea e i moduli che ne compongono il corpo si passa alla scelta del top e dei fianchi.

E' possibile donare alla propria cucina un carattere più forte scegliendo il top e i fianchi **strong da 4 cm** oppure un'estetica più fine selezionando la tipologia **slim da 2cm**. E' selezionabile, inoltre, per la propria cucina un **top con estensione snack** di 30 cm e profondità totale di 100 cm.

## ACCESSORI (4,5 & 6)

E' possibile scegliere se posizionare la propria cucina su **piedi** o su **ruote piroettanti**. Quest'ultima opzione aumenta la mobilità del prodotto e ne facilita lo spostamento all'interno della zona outdoor coperta.

La scelta degli **elettrodomestici** e del **lavello** con i suoi complementi è una parte importante del processo di personalizzazione della cucina outdoor.

Grazie al giusto elettrodomestico e alla presenza o meno del lavello, la cucina può diventare un componente fondamentale per vivere a pieno gli ambienti esterni dell'abitazione.

## TOPS AND SIDES (2 & 3)

After selecting the line and the modules that make up its body, we move on to the choice of the top and sides.

It is possible to give your kitchen a stronger character by choosing the **1 1/2 inches strong** top and sides or a more refined look by selecting the **4/5 inches slim** type.

It is also possible to select a top with a **11 7/8 inches snack extension** and a total depth of **39 3/8 inches** for your kitchen.

## ACCESSORIES (4,5 & 6)

You can choose whether to place your kitchen on **feet** or on **swivel castors**. The latter option increases the mobility of the product and facilitates its movement within the covered outdoor area.

The choice of **appliances** and **sink** with its accessories is an important part of the process of customizing your outdoor kitchen.

With the right appliance and the presence or absence of a sink, the kitchen can become a key component in fully experiencing the outdoors of the home.

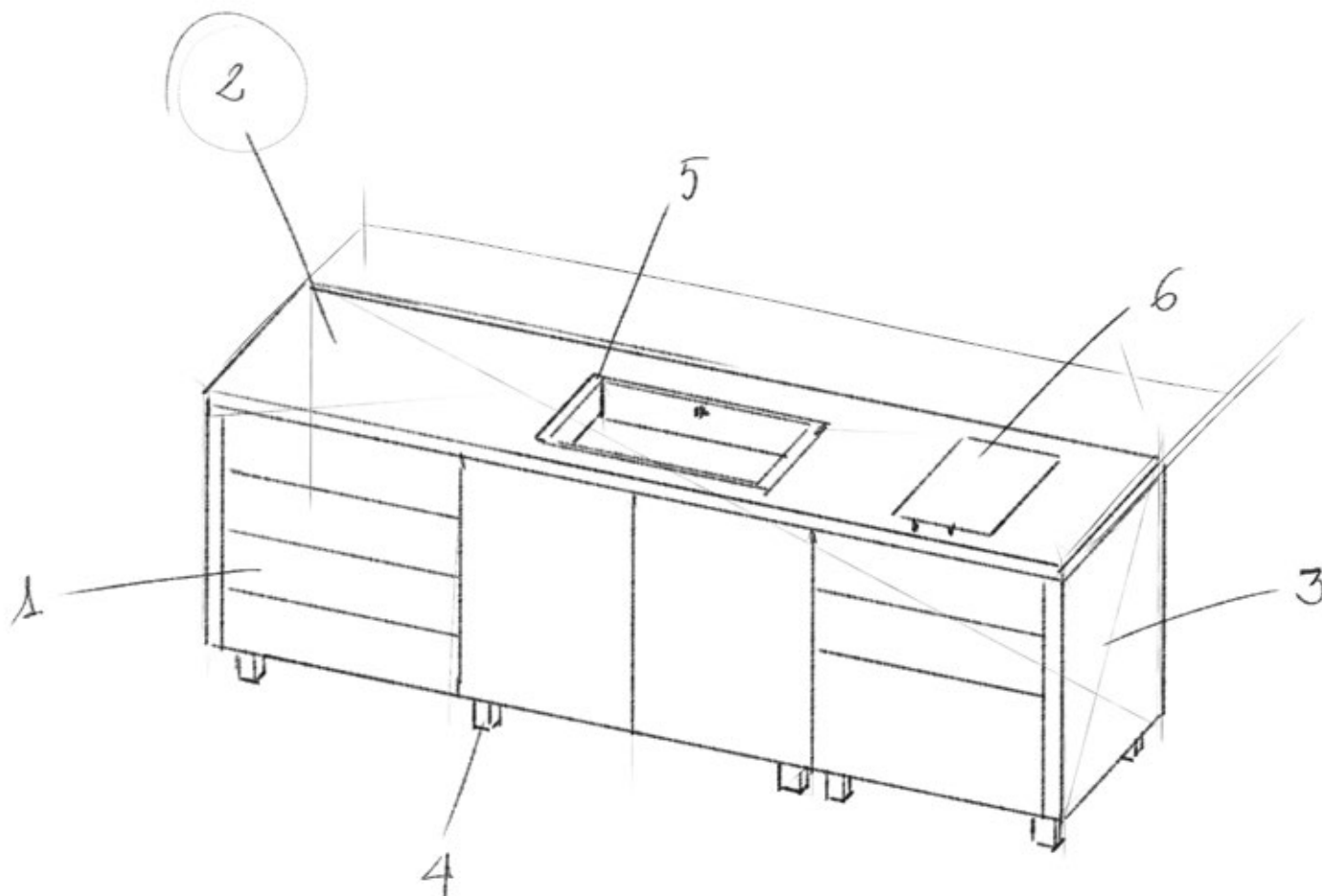





## LINEA ELBA

*BASI CON GOLA 45 - 60 - 90 - 120 cm*

*17 6/8 - 23 3/5 - 35 2/5 - 47 1/4 inches RECESSED GRIP PROFILE BASES*



**BASE SOTTOLAVELLO CON ANTA //  
 UNDER-SINK BASE UNIT WITH DOOR**

*COD 200910*

Altezza // Height 720 mm - 28 3/9 in  
 Profondità // Depth 700 mm - 27 1/2 in

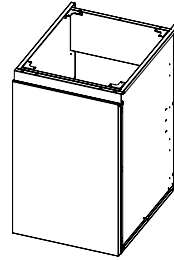

**BASE CON ANTA //  
 BASE WITH DOOR**

*COD 200923*

Altezza // Height 720 mm - 28 3/9 in  
 Profondità // Depth 700 mm - 27 1/2 in

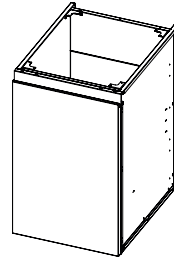

**BASE 2 CASSETTONI //  
 BASE WITH 2 DEEP DRAWERS**

*COD 200919*

Altezza // Height 720 mm - 28 3/9 in  
 Profondità // Depth 700 mm - 27 1/2 in  
 Altezza Cassettone //  
 Deep Drawers Height 357 mm - 14 in

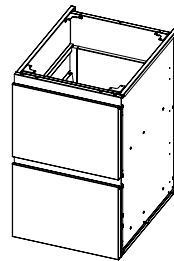

**BASE 1 CASSETTONE E 2 CASSETTI //  
 BASE WITH A DEEP DAWER AND 2 DRAWERS**

*COD 200911*

Altezza // Height 720 mm - 28 3/9 in  
 Profondità // Depth 700 mm - 27 1/2 in  
 Altezza Cassettone //  
 Deep Drawers Height 357 mm - 14 in  
 Altezza Cassetti //  
 Drawers Height 177 mm - 7 in

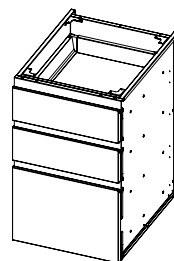

**BASE 4 CASSETTI //  
 BASE WITH 4 DRAWERS**

*COD 200915*

Altezza // Height 720 mm - 28 3/9 in  
 Profondità // Depth 700 mm - 27 1/2 in  
 Altezza Cassetti //  
 Drawers Height 177 mm - 7 in

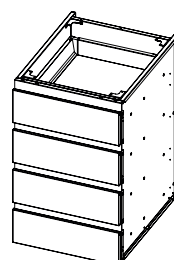



**BASE CON ANTA //**  
**BASE WITH DOOR**

*COD 200503*  
 BASE SOTTOLAVELLO // UNDER-SINK BASE UNIT

Altezza // Height 720 mm - 28 3/9 in  
 Profondità // Depth 700 mm - 27 1/2 in

*COD 200924*  
 BASE UNIT // BASE

Altezza // Height 720 mm - 28 3/9 in  
 Profondità // Depth 700 mm - 27 1/2 in

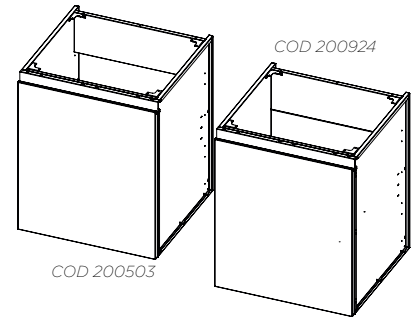

**BASE PER KAMADO //**  
**KAMADO BASE UNIT**

*COD 201094*

Altezza // Height 720 mm - 28 3/9 in  
 Profondità // Depth 700 mm - 27 1/2 in

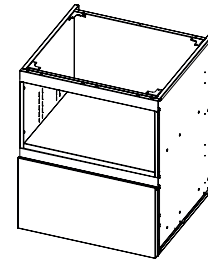

**BASE 2 CASSETTONI //**  
**BASE WITH 2 DEEP DRAWERS**

*COD 200920*

Altezza // Height 720 mm - 28 3/9 in  
 Profondità // Depth 700 mm - 27 1/2 in  
 Altezza Cassettone //  
 Deep Drawers Height 357 mm - 14 in

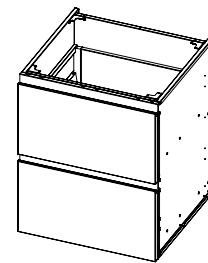

**BASE 1 CASSETTONE E 2 CASSETTI //**  
**BASE WITH A DEEP DAWER AND 2 DRAWERS**

*COD 200912*

Altezza // Height 720 mm - 28 3/9 in  
 Profondità // Depth 700 mm - 27 1/2 in  
 Altezza Cassettone //  
 Deep Drawers Height 357 mm - 14 in  
 Altezza Cassetti //  
 Drawers Height 177 mm - 7 in

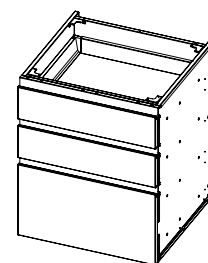

**BASE 4 CASSETTI //**  
**BASE WITH 4 DRAWERS**

*COD 200916*

Altezza // Height 720 mm - 28 3/9 in  
 Profondità // Depth 700 mm - 27 1/2 in  
 Altezza Cassetti //  
 Drawers Height 177 mm - 7 in

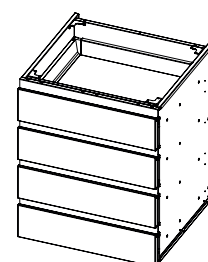



**BASE SOTTOLAVELLO CON ANTA //**  
**UNDER-SINK BASE UNIT WITH DOOR**

COD 200506

Altezza // Height 720 mm - 28 3/9 in  
 Profondità // Depth 700 mm - 27 1/2 in

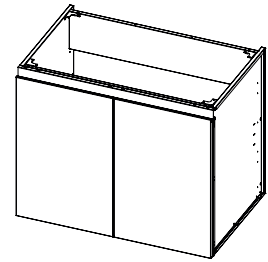

**BASE CON ANTA //**  
**BASE WITH DOOR**

COD 200925

Altezza // Height 720 mm - 28 3/9 in  
 Profondità // Depth 700 mm - 27 1/2 in

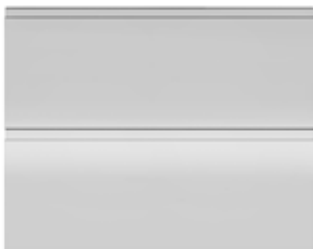
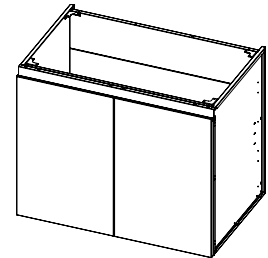

**BASE 2 CASSETTONI //**  
**BASE WITH 2 DEEP DRAWERS**

COD 200921

Altezza // Height 720 mm - 28 3/9 in  
 Profondità // Depth 700 mm - 27 1/2 in  
 Altezza Cassettone //  
 Deep Drawers Height 357 mm - 14 in

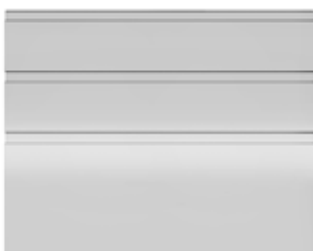
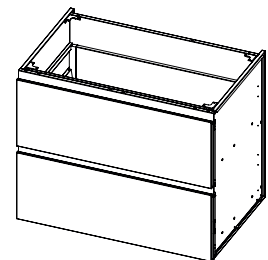

**BASE 1 CASSETTONE E 2 CASSETTI //**  
**BASE WITH A DEEP DAWER AND 2 DRAWERS**

COD 200913

Altezza // Height 720 mm - 28 3/9 in  
 Profondità // Depth 700 mm - 27 1/2 in  
 Altezza Cassettone //  
 Deep Drawers Height 357 mm - 14 in  
 Altezza Cassetti //  
 Drawers Height 177 mm - 7 in

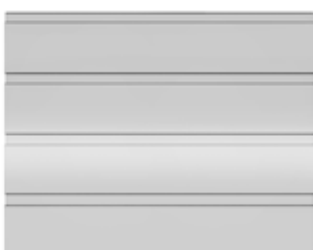
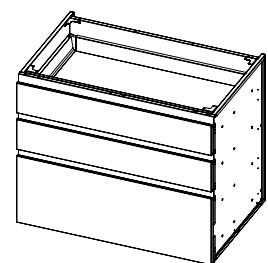

**BASE 4 CASSETTI //**  
**BASE WITH 4 DRAWERS**

COD 200917

Altezza // Height 720 mm - 28 3/9 in  
 Profondità // Depth 700 mm - 27 1/2 in  
 Altezza Cassetti //  
 Drawers Height 177 mm - 7 in

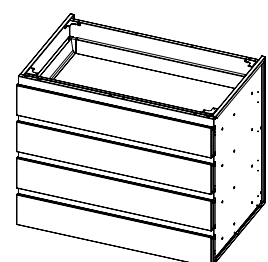



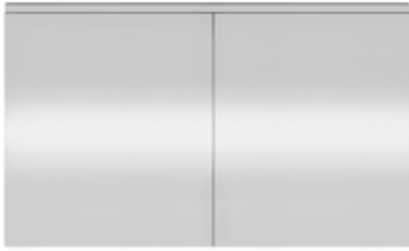

**BASE SOTTOLAVELLO CON ANTA //**  
**UNDER-SINK BASE UNIT WITH DOOR**

*COD 200504*

Altezza // Height 720 mm - 28 3/9 in  
 Profondità // Depth 700 mm - 27 1/2 in

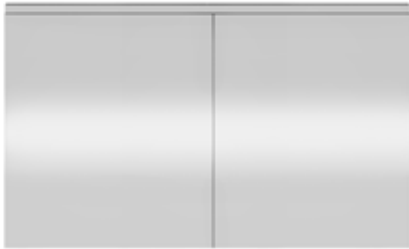
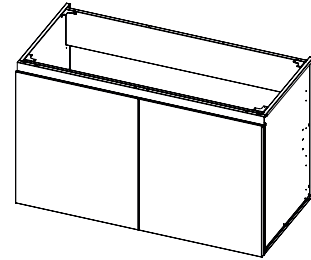

**BASE CON ANTA //**  
**BASE WITH DOOR**

*COD 200926*

Altezza // Height 720 mm - 28 3/9 in  
 Profondità // Depth 700 mm - 27 1/2 in

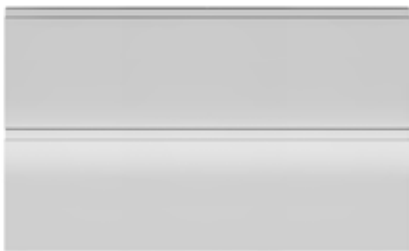
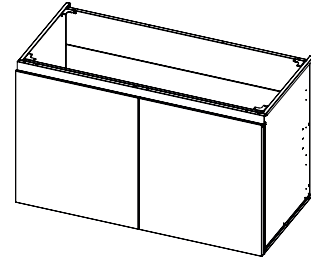

**BASE 2 CASSETTONI //**  
**BASE WITH 2 DEEP DRAWERS**

*COD 200922*

Altezza // Height 720 mm - 28 3/9 in  
 Profondità // Depth 700 mm - 27 1/2 in  
 Altezza Cassettone //  
 Deep Drawers Height 357 mm - 14 in

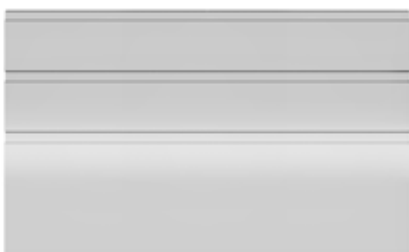
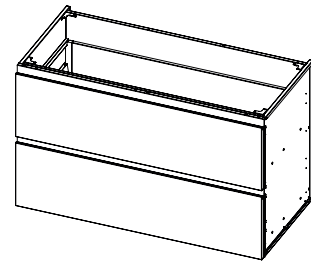

**BASE 1 CASSETTONE E 2 CASSETTI //**  
**BASE WITH A DEEP DAWER AND 2 DRAWERS**

*COD 200914*

Altezza // Height 720 mm - 28 3/9 in  
 Profondità // Depth 700 mm - 27 1/2 in  
 Altezza Cassettone //  
 Deep Drawers Height 357 mm - 14 in  
 Altezza Cassetti //  
 Drawers Height 177 mm - 7 in

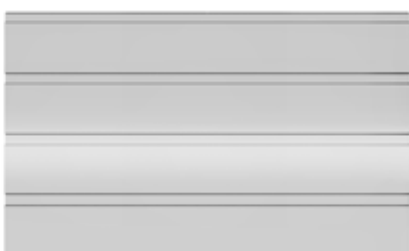
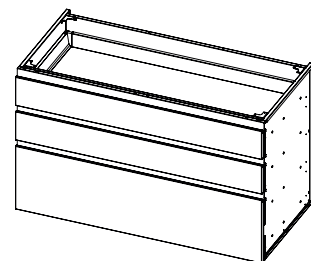

**BASE 4 CASSETTI //**  
**BASE WITH 4 DRAWERS**

*COD 200918*

Altezza // Height 720 mm - 28 3/9 in  
 Profondità // Depth 700 mm - 27 1/2 in  
 Altezza Cassetti //  
 Drawers Height 177 mm - 7 in

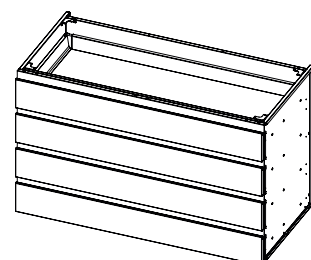





## LINEA PANTELLERIA

BASI CON TIP-ON 45 - 60 - 90 - 120 cm

17 6/8 - 23 3/5 - 35 2/5 - 47 1/4 inches TIP-ON BASES



**BASE SOTTOLAVELLO CON ANTA //  
 UNDER-SINK BASE UNIT WITH DOOR**

*COD 200910*

Altezza // Height 720 mm - 28 3/9 in  
 Profondità // Depth 700 mm - 27 1/2 in

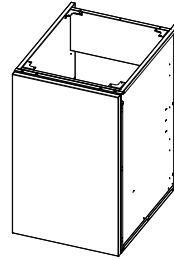

**BASE CON ANTA //  
 BASE WITH DOOR**

*COD 200923*

Altezza // Height 720 mm - 28 3/9 in  
 Profondità // Depth 700 mm - 27 1/2 in

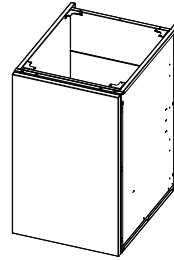

**BASE 2 CASSETTONI //  
 BASE WITH 2 DEEP DRAWERS**

*COD 200935*

Altezza // Height 720 mm - 28 3/9 in  
 Profondità // Depth 700 mm - 27 1/2 in  
 Altezza Cassettone //  
 Deep Drawers Height 357 mm - 14 in

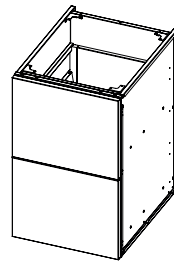

**BASE 1 CASSETTONE E 2 CASSETTI //  
 BASE WITH A DEEP DAWER AND 2 DRAWERS**

*COD 200931*

Altezza // Height 720 mm - 28 3/9 in  
 Profondità // Depth 700 mm - 27 1/2 in  
 Altezza Cassettone //  
 Deep Drawers Height 357 mm - 14 in  
 Altezza Cassetti //  
 Drawers Height 177 mm - 7 in

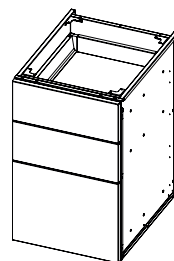

**BASE 4 CASSETTI //  
 BASE WITH 4 DRAWERS**

*COD 200927*

Altezza // Height 720 mm - 28 3/9 in  
 Profondità // Depth 700 mm - 27 1/2 in  
 Altezza Cassetti //  
 Drawers Height 177 mm - 7 in

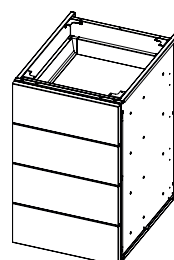



**BASE CON ANTA //**  
**BASE WITH DOOR**

*COD 200503*  
 BASE SOTTOLAVELLO // UNDER-SINK BASE UNIT

Altezza // Height 720 mm - 28 3/9 in  
 Profondità // Depth 700 mm - 27 1/2 in

*COD 200924*  
 BASE UNIT // BASE

Altezza // Height 720 mm - 28 3/9 in  
 Profondità // Depth 700 mm - 27 1/2 in

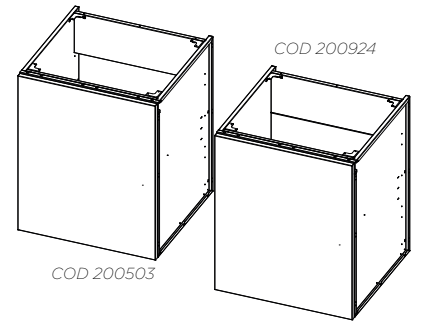

**BASE PER KAMADO //**  
**KAMADO BASE UNIT**

*COD 201094*

Altezza // Height 720 mm - 28 3/9 in  
 Profondità // Depth 700 mm - 27 1/2 in

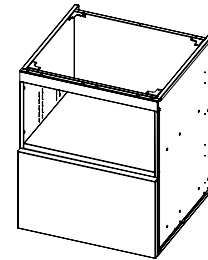

**BASE 2 CASSETTONI //**  
**BASE WITH 2 DEEP DRAWERS**

*COD 200936*

Altezza // Height 720 mm - 28 3/9 in  
 Profondità // Depth 700 mm - 27 1/2 in  
 Altezza Cassettone //  
 Deep Drawers Height 357 mm - 14 in

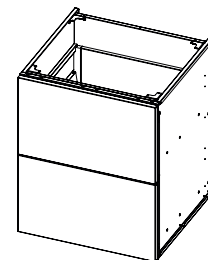

**BASE 1 CASSETTONE E 2 CASSETTI //**  
**BASE WITH A DEEP DAWER AND 2 DRAWERS**

*COD 200932*

Altezza // Height 720 mm - 28 3/9 in  
 Profondità // Depth 700 mm - 27 1/2 in  
 Altezza Cassettone //  
 Deep Drawers Height 357 mm - 14 in  
 Altezza Cassetti //  
 Drawers Height 177 mm - 7 in

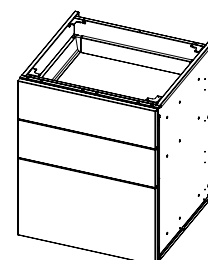

**BASE 4 CASSETTI //**  
**BASE WITH 4 DRAWERS**

*COD 200928*

Altezza // Height 720 mm - 28 3/9 in  
 Profondità // Depth 700 mm - 27 1/2 in  
 Altezza Cassetti //  
 Drawers Height 177 mm - 7 in

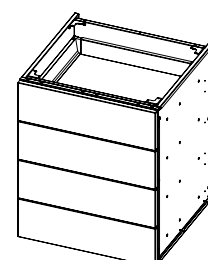

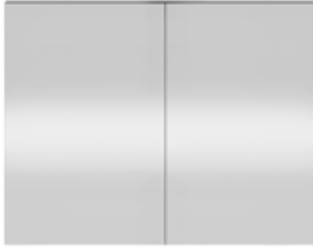

**BASE SOTTOLAVELLO CON ANTA //**  
**UNDER-SINK BASE UNIT WITH DOOR**

*COD 200506*

Altezza // Height 720 mm - 28 3/9 in  
 Profondità // Depth 700 mm - 27 1/2 in

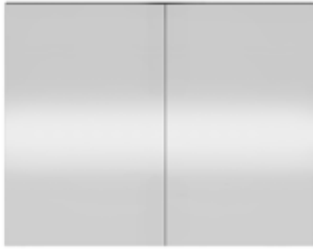
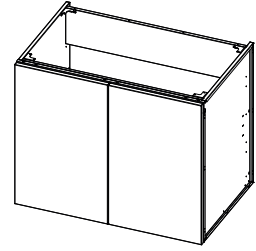

**BASE CON ANTA //**  
**BASE WITH DOOR**

*COD 200925*

Altezza // Height 720 mm - 28 3/9 in  
 Profondità // Depth 700 mm - 27 1/2 in

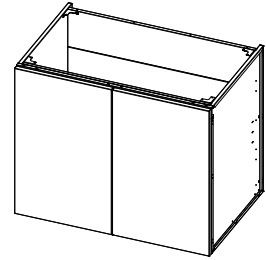

**BASE 2 CASSETTONI //**  
**BASE WITH 2 DEEP DRAWERS**

*COD 200937*

Altezza // Height 720 mm - 28 3/9 in  
 Profondità // Depth 700 mm - 27 1/2 in  
 Altezza Cassettone //  
 Deep Drawers Height 357 mm - 14 in

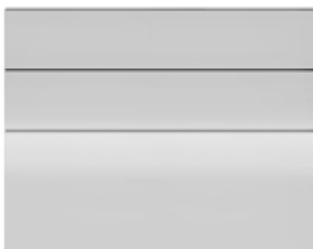
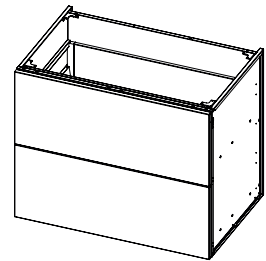

**BASE 1 CASSETTONE E 2 CASSETTI //**  
**BASE WITH A DEEP DAWER AND 2 DRAWERS**

*COD 200933*

Altezza // Height 720 mm - 28 3/9 in  
 Profondità // Depth 700 mm - 27 1/2 in  
 Altezza Cassettone //  
 Deep Drawers Height 357 mm - 14 in  
 Altezza Cassetti //  
 Drawers Height 177 mm - 7 in

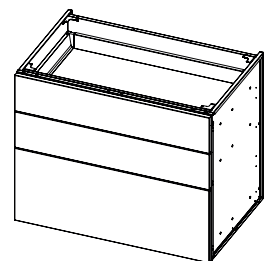

**BASE 4 CASSETTI //**  
**BASE WITH 4 DRAWERS**

*COD 200929*

Altezza // Height 720 mm - 28 3/9 in  
 Profondità // Depth 700 mm - 27 1/2 in  
 Altezza Cassetti //  
 Drawers Height 177 mm - 7 in

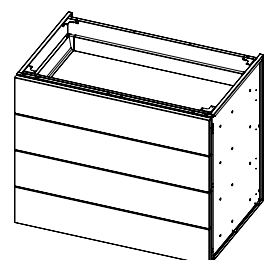

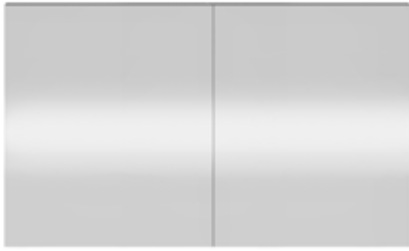

**BASE SOTTOLAVELLO CON ANTA //**  
**UNDER-SINK BASE UNIT WITH DOOR**

COD 200504

Altezza // Height 720 mm - 28 3/9 in  
 Profondità // Depth 700 mm - 27 1/2 in

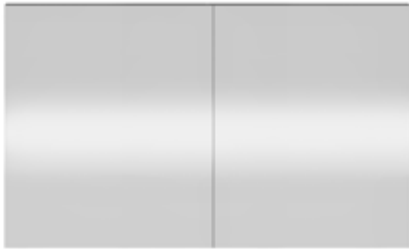
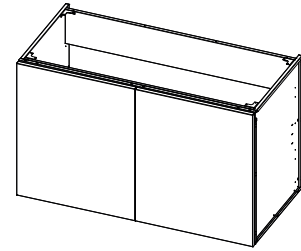

**BASE CON ANTA //**  
**BASE WITH DOOR**

COD 200926

Altezza // Height 720 mm - 28 3/9 in  
 Profondità // Depth 700 mm - 27 1/2 in

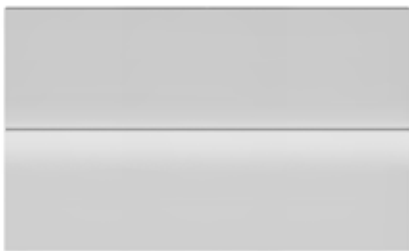
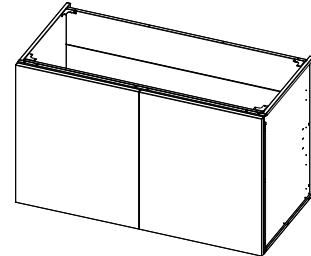

**BASE 2 CASSETTONI //**  
**BASE WITH 2 DEEP DRAWERS**

COD 200938

Altezza // Height 720 mm - 28 3/9 in  
 Profondità // Depth 700 mm - 27 1/2 in  
 Altezza Cassettone //  
 Deep Drawers Height 357 mm - 14 in

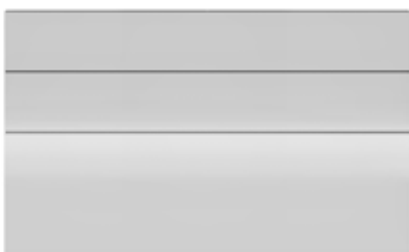
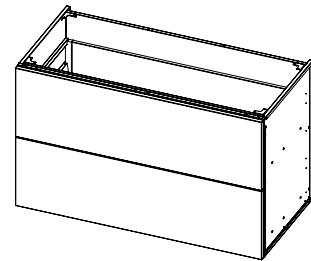

**BASE 1 CASSETTONE E 2 CASSETTI //**  
**BASE WITH A DEEP DAWER AND 2 DRAWERS**

COD 200934

Altezza // Height 720 mm - 28 3/9 in  
 Profondità // Depth 700 mm - 27 1/2 in  
 Altezza Cassettone //  
 Deep Drawers Height 357 mm - 14 in  
 Altezza Cassetti //  
 Drawers Height 177 mm - 7 in

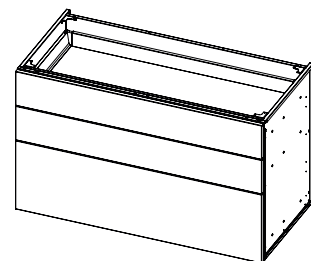

**BASE 4 CASSETTI //**  
**BASE WITH 4 DRAWERS**

COD 200930

Altezza // Height 720 mm - 28 3/9 in  
 Profondità // Depth 700 mm - 27 1/2 in  
 Altezza Cassetti //  
 Drawers Height 177 mm - 7 in

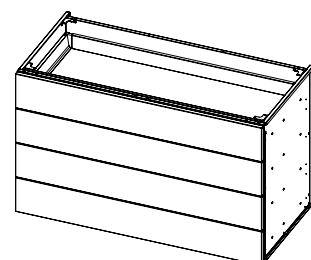

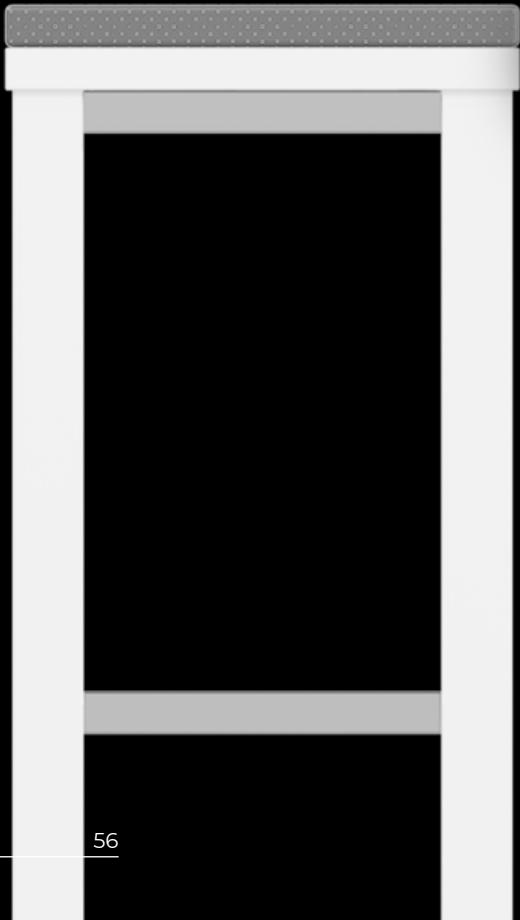



## ACCESSORI // ACCESSORIES

Rendi la cucina unica in ogni particolare

*Make the kitchen unique in every detail*





**LAVELLO APELL 70 cm //**  
**APELL 70 cm SINK**

*COD LNR74FSFR*

Lavello Apell in acciaio inox 304 scotch brite sopra top di 70 cm di larghezza interna e raggio 10 mm.

*Apell 304 scotch brite stainless steel 27 1/2 in internal sink above worktop with width and 2/5 in radius.*

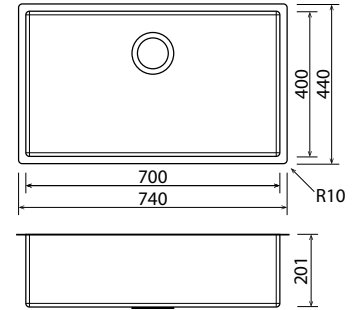

**LAVELLO APELL 50 cm //**  
**APELL 50 cm SINK**

*COD LNR54FSFR*

Lavello Apell in acciaio inox 304 scotch brite sopra top di 50 cm di larghezza interna e raggio 10 mm.

*Apell 304 scotch brite stainless steel 19 6/9 in internal sink above worktop with width and 2/5 in radius.*

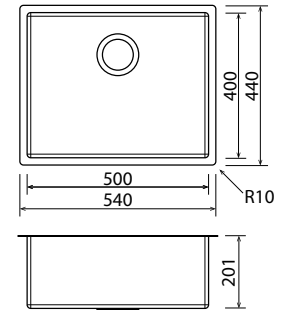

**LAVELLO APELL 34 cm //**  
**APELL 34 cm SINK**

*COD LNR38FSFR*

Lavello Apell in acciaio inox 304 scotch brite sopra top di 34cm di larghezza interna e raggio 10mm.

*Apell 304 scotch brite stainless steel 13 2/5 in internal sink above worktop with width and 2/5 in radius.*

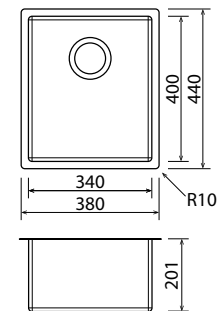

**MISCELATORE APELL //**  
**APELL MIXER TAP**

*COD AP6040SS*

Miscelatore monocomando Apell in acciaio inox. Altezza 30,6 cm dal top. Erogatore di 21,8 cm di profondità.

*Apell single-lever mixer tap in stainless steel. Height 12 in from top. Depth 8 3/5 in.*

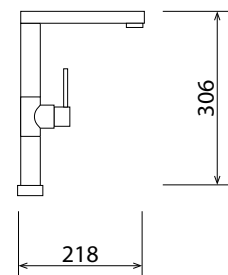

**MISCELATORE ABBATTIBILE LISA //**  
**LISA HIDDEN MIXER TAP**

*COD MM00000334*

Miscelatore abbattibile della Lisa con monocomando in acciaio inox.

*Lisa hidden mixer tap with single-lever in stainless steel.*

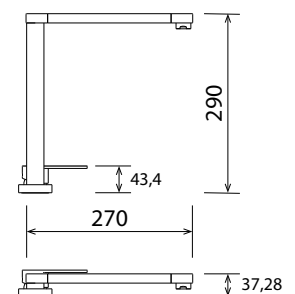



**BARBECUE A GAS FÒGHER //  
 FÒGHER GAS BARBECUE**

COD 1072485

Barbecue a Gas Fògher. Due Bruciatori da 2,5 Kw l'uno. 1 Griglia di cottura e 1 Piastra di cottura in acciaio inox.

*Fògher Gas Barbecue. Two 2.5 Kw burners each. 1 cooking grill and 1 stainless steel cooking plate.*

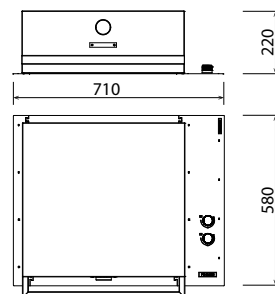

**INDUZIONE SMEG STAND ALONE //  
 SMEG INDUCTION STAND ALONE**

COD OUT010IS

Fornello a induzione Smeg da appoggio. Indipendente dal top. Color acciaio inox effetto satinato.

*Smeg countertop induction cooker. Free-standing. Satin-finish stainless steel colour. Pot size detection and adjustment system.*

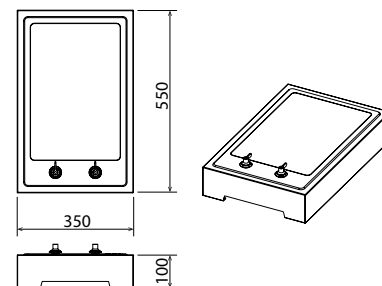

**INDUZIONE FABITA STAND ALONE //  
 FABITA INDUCTION STAND ALONE**

COD OUT010IF

Fornello a induzione Fablta da appoggio. Indipendente dal top. Color nero lucido e acciaio inox effetto satinato.

*Fablta countertop induction cooker. Top-independent. Glossy black and satin-finish stainless steel.*

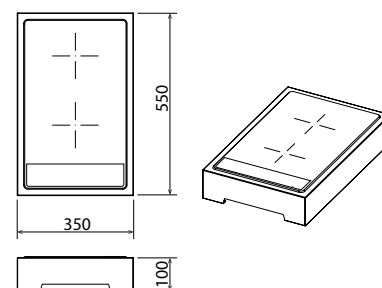

**TEPPAN YAKI SMEG STAND ALONE //  
 SMEG TEPPAN YAKI STAND ALONE**

COD OUT010TS

Teppan Yaki Smeg da appoggio. Indipendente dal top. Color acciaio inox effetto satinato. Sistema di auto-arresto in caso di surriscaldamento.

*Teppan Yaki Smeg countertop. Free-standing. Satin-finish stainless steel colour. Auto-stop system in the event of overheating.*

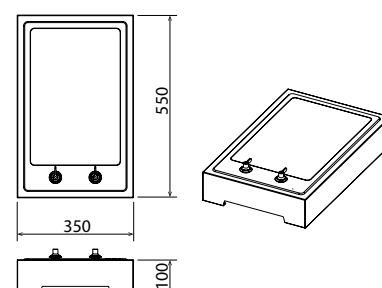

**BARBECUE ELETTRICO SMEG STAND ALONE  
 // SMEG ELECTRIC GRILL STAND ALONE**

COD OUT010BS

Barbecue elettrico Smeg da appoggio. Indipendente dal top. Color acciaio inox effetto satinato con griglia in Ghisa.

*Smeg free-standing electric grill. Free-standing. Satin-finish stainless steel colour with cast iron grill.*

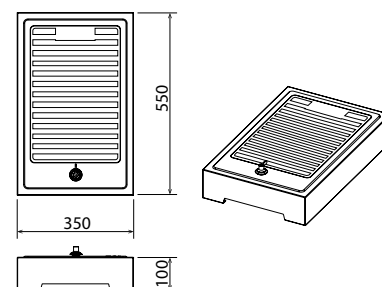



### SGABELLO // STOOL

COD OUT009B

Sgabello in ferro verniciato bianco con poggia piedi e supporti in acciaio inox.

*A white painted iron stool with stainless steel footrest and supports.*

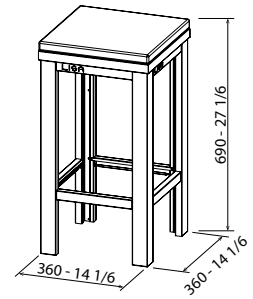

### PIEDE FISSO IN ACCIAIO // FIXED STEEL FOOT

COD MM00000227

Piedino con piastra in acciaio inox, alto 100 mm, regolabile in altezza di 15mm. Portata 40Kg.

*Foot with stainless steel plate, 4 in high, height adjustable by 3/5 in. Load capacity 40 kg*

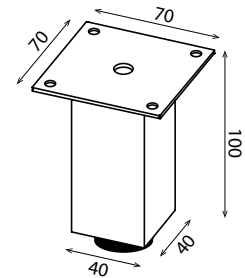

### RUOTA SENZA FRENO // WHEEL WITHOUT BRAKE

COD MM00000258

Ruota piroettante in alluminio con gomma nera. Attacco con piastra. Portata 80Kg.

*Aluminium swivel castor with black rubber. Hitch with plate. Load capacity 80 kg.*

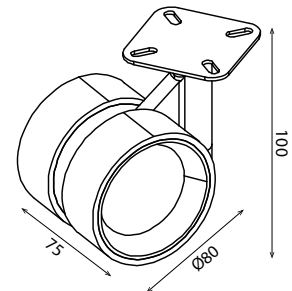

### RUOTA CON FRENO // WHEEL WITH BRAKE

COD MM00000259

Ruota piroettante in alluminio con gomma nera e freno. Pedale freno color nero. Attacco con piastra. Portata 80Kg.

*Aluminium swivel castor with black rubber and brake. Black brake pedal. Hitch with plate. Load capacity 80 kg*

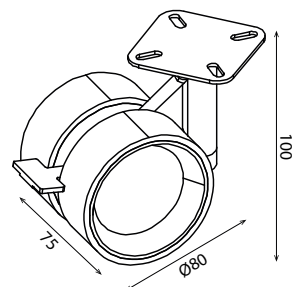



**FINITURA ACCIAIO // BRUSHED STEEL FINISH**

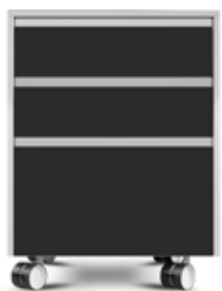

**FINITURA ANTRACITE // ANTHRACITE FINISH (RAL 9004)**

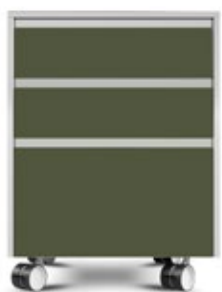

**FINITURA VERDE // GREEN FINISH (RAL 6003)**



**FINITURA BIANCA // WHITE FINISH (RAL 9001)**



—

—

Via Raiale 291  
65128 Pescara (PE)  
ITALY  
+39 085 43 08 333

